

· INSTALLATION INSTRUCTIONS ·

Live ends (feed) and
couplers | standard

EUTRAC®

2~

**2 Circuit (120V)
Tracks and Adaptors
www.EUTRAC.com**

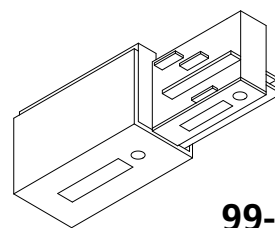

**99-800-
99-801-**

INSTALLATION INSTRUCTION

- **READ ALL OF THESE INSTALLATION INSTRUCTIONS BEFORE INSTALLING THE EUTRAC TRACK SYSTEMS.**
- **SAVE THESE INSTRUCTIONS AND REFER TO THEM WHEN ADDITIONS TO OR CHANGES IN THE TRACK CONFIGURATION ARE MADE.**
- Track is only to be used with other electrical fittings identified for use with the EUTRAC track system 230 .
- To be installed by trained personnel only (electricans).
- The Installation and operation of this track system are subject to national safety regulations.
The manufacturer is not liable for damage caused by improper use or installation.
If any track system components is subsequently modified, the person responsible for the modification shall be considered as manufacturer.
- It is the responsibility of the installer to ensure the electrical, mechanical and thermal compatibility of the track system and the fittings.
- Materials used for ceiling fixation should conform to the relevant building regulations.
- It is essential to cover the ends of the track with end covers or protective caps.
- This track system is not intended for use with a power supply cord or convenience receptable adaptor.

IMPORTANT SAFETY INSTRUCTIONS

- **READ ALL INSTRUCTIONS.**
- Do not install this track in damp or wet locations.
- Do not install any part of a track system less 5 ft. above the floor.
- Do not install any fixture assembly closer than 6 in. from any curtain or similar combustible material.
- Disconnect electrical power before adding to or changing the configuration of the track.
- Do not attempt to energize anything other than lighting track fixtures on the track.
In order to reduce the risk of fire and electrical shock, do not attempt to connect power tools, extension cords, appliances and the like to the track.
- (For track lighting systems other than 120V, two circuit.)
Do not connect the track to more than the branch circuit unless the track is constructed so that it can be used with more than one branch circuit.
Check with a qualified electrician. Although the track lighting system may seem to operate appropriately, a dangerous overload of the neutral may occur and result in a risk of fire.
- **SAVE THESE INSTRUCTIONS.**

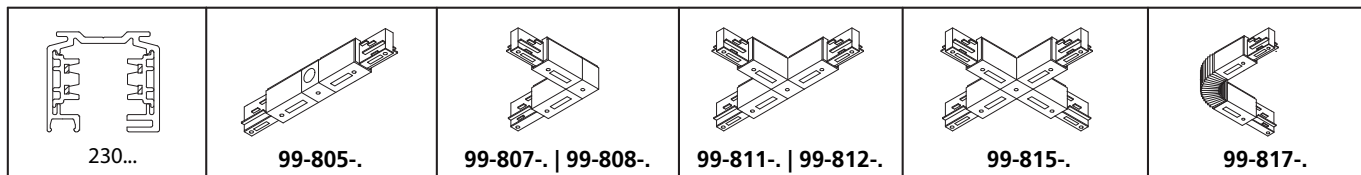

UL US
LISTED
TRACK LIGHTING FITTING
44WB

22.08.2011

Page **1/3**

128926

MT 5.621/3

• INSTALLATION INSTRUCTIONS •

Live ends (feed) and
couplers | standard

EUTRAC® 2~

2 Circuit (120V)
Tracks and Adaptors
www.EUTRAC.com

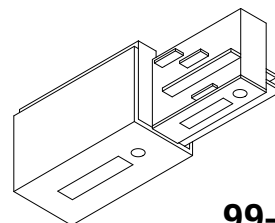

99-800-
99-801-

Please notice:

Feed from the top:

The cover plate has to be broken off.

Feed from the side:

The end cap must be removed and replaced
by a rubber grommet.

Remove burrs after cutting.

Example: 99-801-

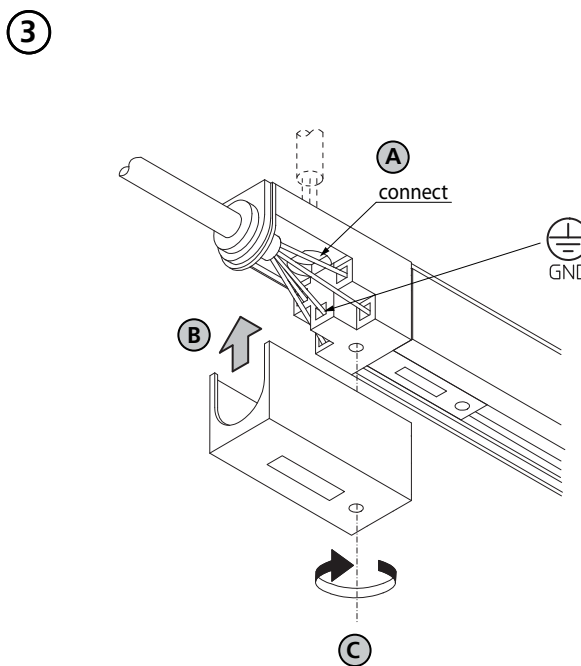
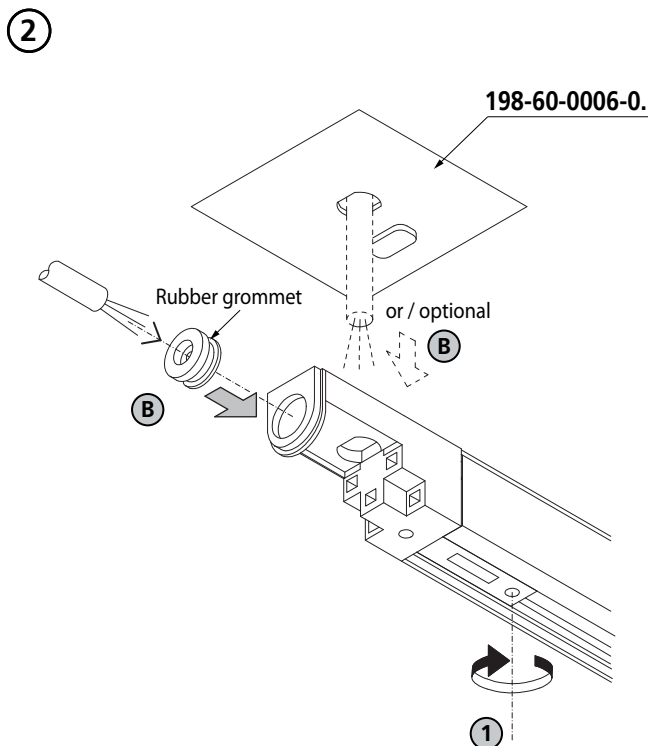
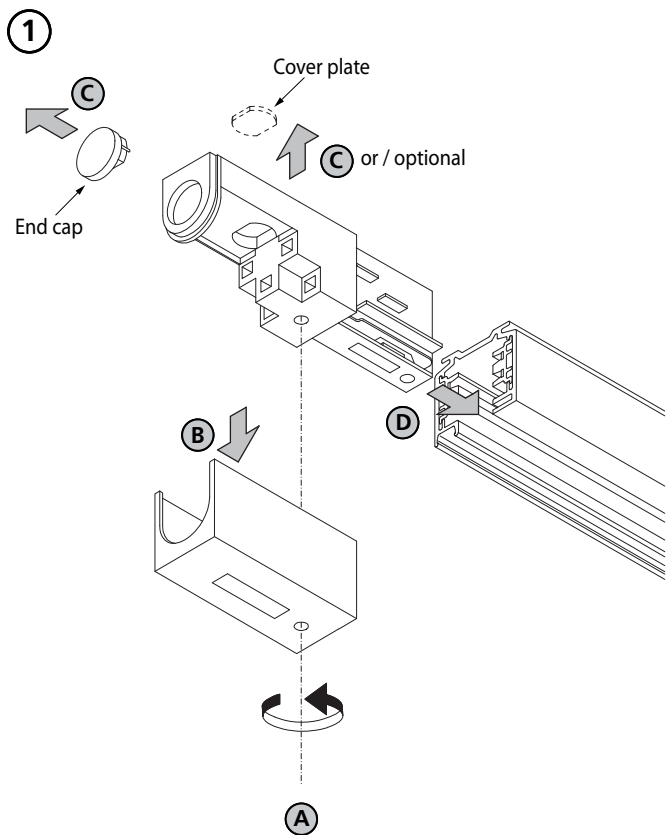

UL US
LISTED
TRACK LIGHTING FITTING
44WB

22.08.2011

Page 2/3

128926

MT 5.621/3

• INSTALLATION INSTRUCTIONS •

Live ends (feed) and couplers | standard

EUTRAC® 2~

2 Circuit (120V)
Tracks and Adaptors
www.EUTRAC.com

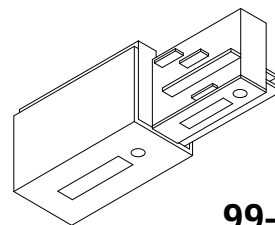

99-800-.
99-801-.

Live ends (feed) and couplers | standard

$\approx 120\text{ V}$
 $P_{\text{max.}} = 5.540\text{VA}$

$\equiv = 2 \times 20\text{A}$
 $\varnothing_{\text{min.}} = 3 \times \text{AWG } 12$

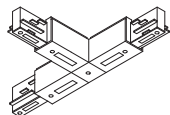
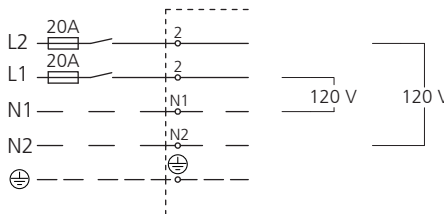

99-812-.

Earth connect left.

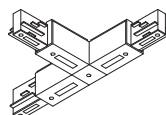
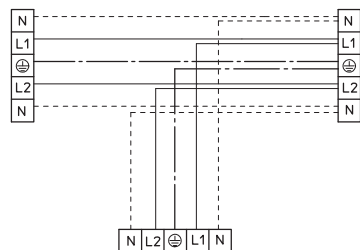

99-811-.

Earth connect right.

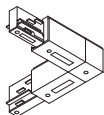
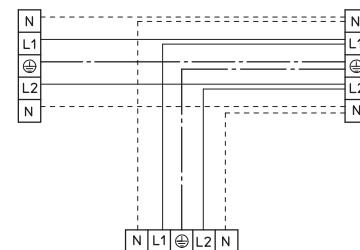

99-807-.

Earth connect inside.

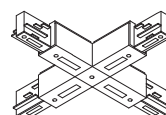
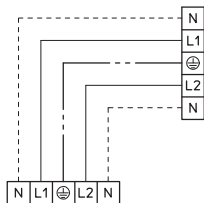

99-815-.

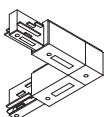
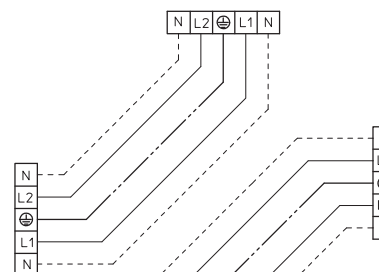

99-808-.

Earth connect outside.

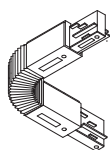
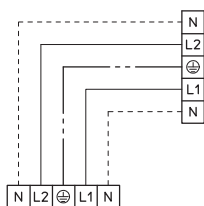

99-817-.

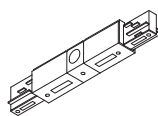

99-805-.

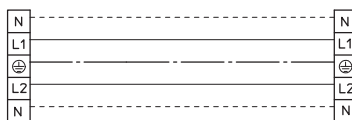

22.08.2011

Page 3/3

128926

MT 5.621/3